

# Technical Instruction

**FISBA READYBeam™**

**A compact multi-wavelength laser module**





# Content

<b>1</b>	<b>Safety</b>	<b>4</b>
1.1	Explanation of symbols	4
1.1.1	General safety instructions	4
1.1.2	Laser safety	4
1.1.3	Laser area	4
1.2	Warning and information labels	6
1.3	Correct and specified use of the unit	6
1.4	Warranty conditions	7
1.4.1	Limits of the warranty	7
<b>2</b>	<b>Technical system</b>	<b>7</b>
2.1	Laser module	7
2.2	Installation and commissioning	8
2.2.1	Unpacking and checking for visible damage	8
2.2.2	Installation	8
2.2.3	Operating the FISBA READYBeam™	8
2.2.4	Software Setup	8
2.2.5	Software interface	9
2.2.6	Modulation mode	10
	Appendix	12
	Data sheet	14

# 1 Safety

## 1.1 Explanation of symbols



This symbol is used for all points in these operating instructions to which special attention is to be paid so that all directives, regulations, instructions and the correct work sequence are observed, and to prevent minor or serious damage to the laser system or plant.

### 1.1.1 General safety instructions

The operating instructions and the safety instructions are to be read and observed prior to installation and commissioning! The operating instructions must be read, understood and followed by the operators responsible for the unit. Along with the instructions in these operating instructions, also observe the generally applicable safety and accident prevention regulations! All work on installation and commissioning as well as all maintenance is to be performed by appropriately qualified personnel. National accident prevention regulations, EN and IEC standards are to be observed. Appropriately qualified personnel in the context of these basic safety instructions are persons who are familiar with the fitting, installation, placing in operation and operation of the product and have qualifications appropriate to their task.

### 1.1.2 Laser safety

The unit is a class 3B laser device. Both the direct beam and its reflections from diffuse reflective surfaces are dangerous. The unit emits strong power beams in the visible spectral range (approx. 400 nm to 700 nm, for more detailed information see the data sheet, page 14). The radiation can cause irreversible damage to the eyes if the necessary protective measures are not taken.

### 1.1.3 Laser area



The laser area is the area in which the values for the maximum permissible irradiation can be exceeded. Here the possibility of unintentional deflection of the laser beam is also to be taken into account. If operational equipment other than that given in this manual or another procedure is used, dangerous exposure to the radiation may result.

#### **Laser system screened inside a protective cover**

By using suitable screening it can be ensured that people are not exposed to the laser radiation. In this way the laser class is reduced and it is possible to work with the closed arrangement without additional limitations or further measures.

However, in this case the following requirements apply to the protective cover:

- The protective cover must be appropriate to adequately shield the laser radiation. It is therefore necessary to use laser safety glass or laser safety film for viewing windows.
- The cover itself as well as any doors or flaps in the cover must be protected using the interlock circuit that automatically shuts down and inhibits the laser immediately on intentional or unintentional opening.

If the interlock circuit is disabled for service or maintenance work on the system with the cover open, the laser area is enlarged again and the regulations in the next section "Presence of persons in the laser area" apply.

### **Presence of persons in the laser area**



In the laser area, people are subject to hazards, in particular ocular. Therefore the following measures must be taken and the following safety regulations observed:

- The room must have an emergency exit.
- The room must be optically screened from the environment (e.g. laser safety film on the windows).
- The laser area is to be kept as small as possible, to be bounded by suitable screening and protected against access by unauthorized persons. The number of persons in the laser area should be reduced to the minimum.
- There must be a warning device on all entrances to the room that indicates the laser radiation hazard.
- If the entry doors are not protected using the interlock circuits, opening the doors easily from the outside must be impossible to prevent thoughtless entry.
- All persons who are in the laser area during operation must be informed about the dangers of the laser radiation.
- Laser safety glasses/goggles must be worn in the laser area. The operating organisation must ensure that suitable safety glasses/goggles are available. The glasses/goggles are selected in accordance with DIN EN 207. Please see the data sheet on the unit for the actual wavelength of your laser. Hereinafter, the term safety glasses is always used to refer to suitable laser safety glasses/goggles. **Caution:** in some circumstances your laser safety glasses/goggles may not protect you from a powerful red pilot beam.
- There must not be any potentially explosive substances in the laser area. Easily inflammable substances may catch fire.
- Glossy reflective equipment must be either removed from the laser area or covered. Windows and reflecting walls are also to be covered with material with low inflammability.

## 1.2 Warning and information labels

The following warning labels are fitted to laser and processing head:



<p><b>VISIBLE LASER RADIATION AVOID EXPOSURE TO BEAM</b></p> <p><b>CLASS 3B LASER PRODUCT</b></p> <table border="1"> <thead> <tr> <th><math>\lambda</math> [nm]</th> <th>max. power [mW]</th> </tr> </thead> <tbody> <tr> <td>400-410</td> <td>210</td> </tr> <tr> <td>486-490</td> <td>55</td> </tr> <tr> <td>632-643</td> <td>155</td> </tr> </tbody> </table> <p>EN 60825-1:2014</p>	$\lambda$ [nm]	max. power [mW]	400-410	210	486-490	55	632-643	155	<p><b>VISIBLE LASER RADIATION AVOID EXPOSURE TO BEAM</b></p> <p><b>CLASS 3B LASER PRODUCT</b></p> <table border="1"> <thead> <tr> <th><math>\lambda</math> [nm]</th> <th>max. power [mW]</th> </tr> </thead> <tbody> <tr> <td>440-460</td> <td>110</td> </tr> <tr> <td>515-530</td> <td>70</td> </tr> <tr> <td>652-664</td> <td>105</td> </tr> </tbody> </table> <p>EN 60825-1:2014</p>	$\lambda$ [nm]	max. power [mW]	440-460	110	515-530	70	652-664	105
$\lambda$ [nm]	max. power [mW]																
400-410	210																
486-490	55																
632-643	155																
$\lambda$ [nm]	max. power [mW]																
440-460	110																
515-530	70																
652-664	105																
 <div style="float: right; font-size: 2em;">CE</div> <p>This product does not conform to 21CFR 1040 and EN 60825-1. It is intended to be integrated in OEM equipment only.</p>	 <p>Laser radiation ! Avoid direct exposure to beam</p> <hr/> <p>400 – 700 nm    Class 3B Max. 500 mW    laser product</p>																

The READYBeam is an OEM certified laser. Please be advised that it has no dedicated Key Switch. If operated via PC with the software installed, be cautioned that suddenly unplugging it during "Lasing," will cause it to emit radiation when plugged in the next time. Always make sure to turn it to the "off" position prior to shutting down the computer.

## 1.3 Correct and specified use of the unit

It is forbidden to commission the laser system until it has been ensured that the machine or plant in which the laser system has been fitted complies with the applicable safety regulations. The organisation operating the plant is solely liable for any damage caused by incorrect use of the unit. The organisation operating the system is responsible for the correct conditions in relation to operation, maintenance and repair. The only personnel to be tasked with operation, maintenance and repair are personnel who have been adequately instructed in the function of the laser system and who have also been instructed specifically on the dangers and risks of incorrect handling of the system.

## 1.4 Warranty conditions

The warranty period is 12 months from delivery. The warranty covers the entire laser module. The warranty will become void on the

- unauthorized opening of the unit's components
- operation of the unit in an unauthorized configuration
- improper use, storage or transport (e.g. vibration, temperature shock, the action of frost)

### 1.4.1 Limits of the warranty

No warranty of the suitability of the product for specific applications is provided. FISBA is not liable for indirect, direct or consequential damages caused by the use of this product.

## 2 Technical system



The laser module emits laser radiation with different wavelengths. Combination of different laser diodes can emit radiation in the UV, VIS and/or NIR range. The different combinations are documented within the data sheet, see page 14.

### 2.1 Laser module

Dimensions of the laser module in mm:

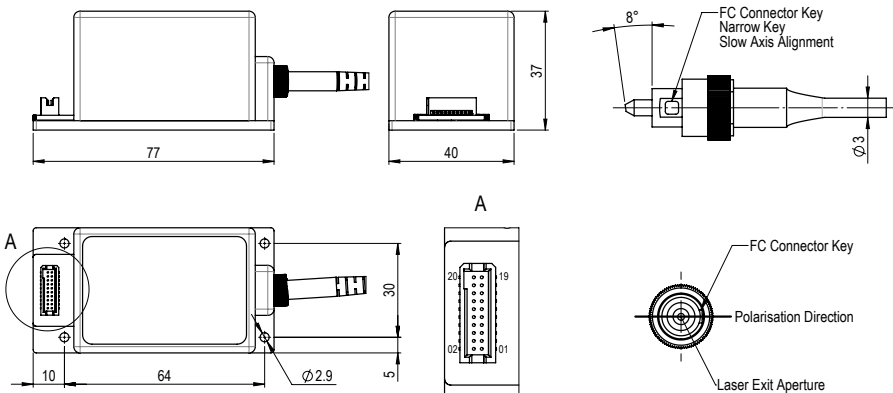

Connector: Samtec SFSD-10-28G24.00SR

Pin assignment: documented in the appendix (Table 1 on page 12)

## 2.2 Installation and commissioning



Note that the laser module with electronic driver is not a product for direct use. Security elements, such as interlock, and emergency switch are not included in the laser module. If the laser module is used as part of system or product, then the responsibility for safety lies with the product development team of the product. When operating the laser module, the laser safety regulations must be observed.

### 2.2.1 Unpacking and checking for visible damage

Check the completeness of the delivery and check that all the items supplied are in good condition. In case of errors please contact FISBA AG ([readybeam@fisba.com](mailto:readybeam@fisba.com)). If possible, keep the packaging in which the laser system was supplied. It will then be possible to pack the unit in its original packaging and transport it safely in case of repair.

### 2.2.2 Installation

The laser module can be mounted with screws on a flat bottom plate. The bottom plate should be cooled and the heat transfer should be at least 7W to hold the module on a stable operating temperature. The laser module READYBeam is TEC-controlled.



Incorrect cooling effects the laser power and can destroy the laser diodes. During assembly of the laser module on a plane cooling surface, attention is required so that no tension can apply to the casing. Tension influences the beam quality very strongly. The connection must be handled carefully.

### 2.2.3 Operating the FISBA READYBeam™

- The safety regulations must be carefully observed
- A power supply between +12 and +24V with max. 4 Ampere is needed to start the READYBeam
- FISBA READYBeam™ can be started digital with the software application and RS485 interface or analog based controlled

### 2.2.4 Software Setup

- Visit [fisba.com/readybeam-software](http://fisba.com/readybeam-software) to download the software
- Unpack the files from downloaded folder
- Start "RGB Service Software Setup.msi" and follow the installation instructions
- You need an USB - RS485 interface cable for the digital operating mode  
See the details in the appendix (Figure 1 on page 13)



- Connect the USB plug to your laptop and the RS485 plug to the laser module interface cable
- Connect the power supply to the interface cable
- Connect the interface cable to the laser module connector
- Start the READYBeam software
- Now it is possible to control the lasers via the software

## 2.2.5 Software interface

The software interface allows a fast start up of the READYBeam with all main functions.

- Connect power supply
- Connect RS485 interface cable
- Connect the interface cable to the READYBeam
- Switch On +12/+24V Power
- Start software
- Wait 1 minute for temperature stabilization

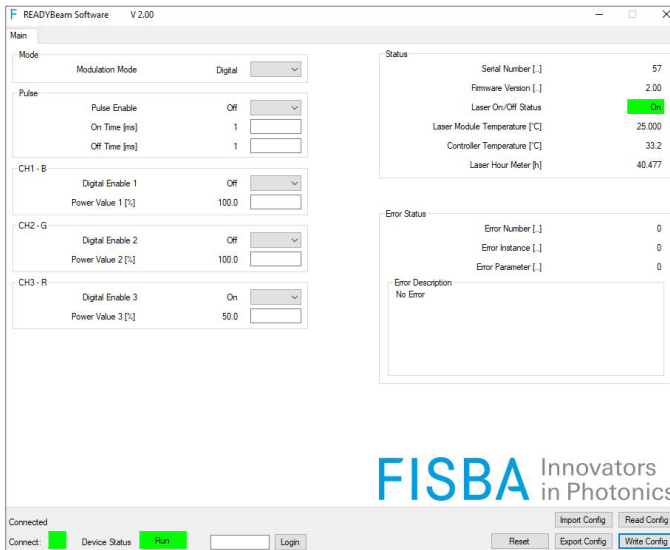

1. Set **Modulation Mode**: choose "Digital"
2. Set **Power Value 1** (red), **Power Value 2** (green) and **Power Value 3** (blue): values in % of the max. laser power
3. Switch the Laser on/off with **Digital Enable 1, 2 or 3**
4. Enter the command with "**Write Config**" Button

The READYBeam software is provided for download at:  
[fisba.com/readybeam-software](http://fisba.com/readybeam-software)

## 2.2.6 Modulation mode

On the Interface, the three channels can be set as either on “Digital” to control On/Off modulation via software with a maximum pulse frequency of 100 Hz, or to “Analog” for external control in On/Off mode or continuous waveform modulation.

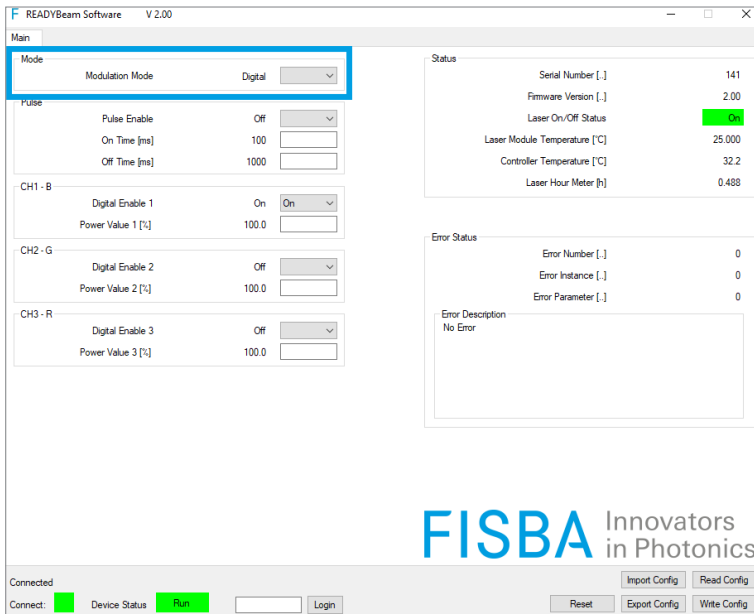

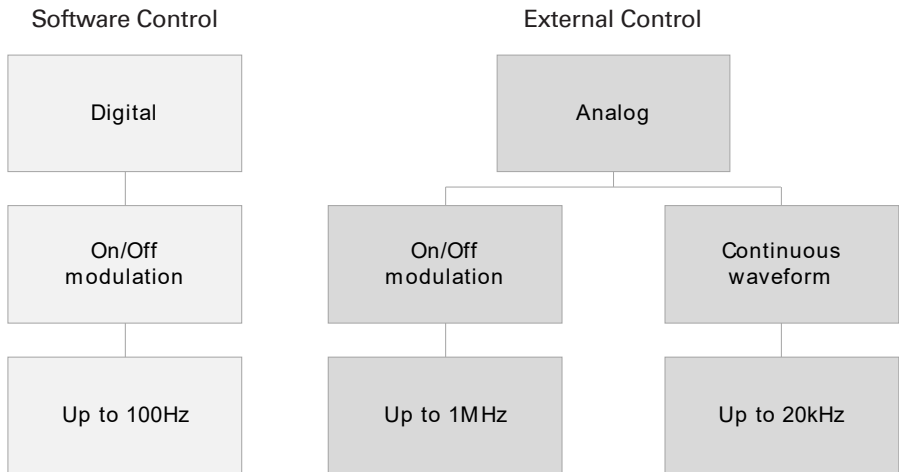

### On/Off modulation

On/Off modulation is best when the operator wants fast and accurate modulation with discrete signals. Digital modulation is possible with two options. Option one is over the SW up to 100Hz. Option two over a 0-3.3V TTL input signal up to 1MHz. For digital modulation over SW, choose "Digital" from the "Modulation Mode" drop-down menu on the main screen and set "Pulse Enable" to ON and set "OnTime " and "OffTime". The unit of On and OffTime is ms. For digital modulation over TTL input signal, choose "Analog" from the "Modulation Mode" drop-down menu on the main screen and use a function generator or a similar external signal source for the 0-3.3V TTL input Signal. A function generator, or similar external signal source, is needed to drive the modulation.

### Continuous waveform

To modulate the laser power choose "Analog" from the "Modulation Mode" drop-down menu. The signal is calibrated from 0.33V to 3.3V. This correlates with 10% to 100% of laser power. Below 0.33V the laser power is not longer linear and below the threshold current the laser is no longer in lasing mode. A function generator, or similar external signal source, is needed to drive the modulation.

## Appendix

### Pin configuration and power values

Connector: Samtec SFSD-10-28G24.00SR  
 Enable Laser: low = 0V, high = 3.3V  
 Analog In: 0.33V ... 3.3V → 10% ...100% of Laser power  
 Power: +12V ... + 24V max. 4A

Pin 1 is marked on the connector with arrow (not notch)		
Pin 1	Analog In- Laser red	brown
Pin 2	Analog In+ Laser red	red
Pin 3	Analog In- Laser green	orange
Pin 4	Analog In+ Laser green	yellow
Pin 5	Analog In- Laser blue	green
Pin 6	Analog In+ Laser blue	violet
Pin 7	Gnd	gray
Pin 8	Enable Laser red	white
Pin 9	Enable Laser green	black
Pin 10	Enable Laser blue	blue
Pin 11	RS 485 B	brown
Pin 12	RS 485 A	red
Pin 13	Gnd	orange
Pin 14	Gnd	yellow
Pin 15	Gnd	green
Pin 16	Gnd	violet
Pin 17	Power +12V ... +24V	gray
Pin 18	Power +12V ... +24V	white
Pin 19	Power +12V ... +24V	black
Pin 20	Power +12V ... +24V	blue

Table 1

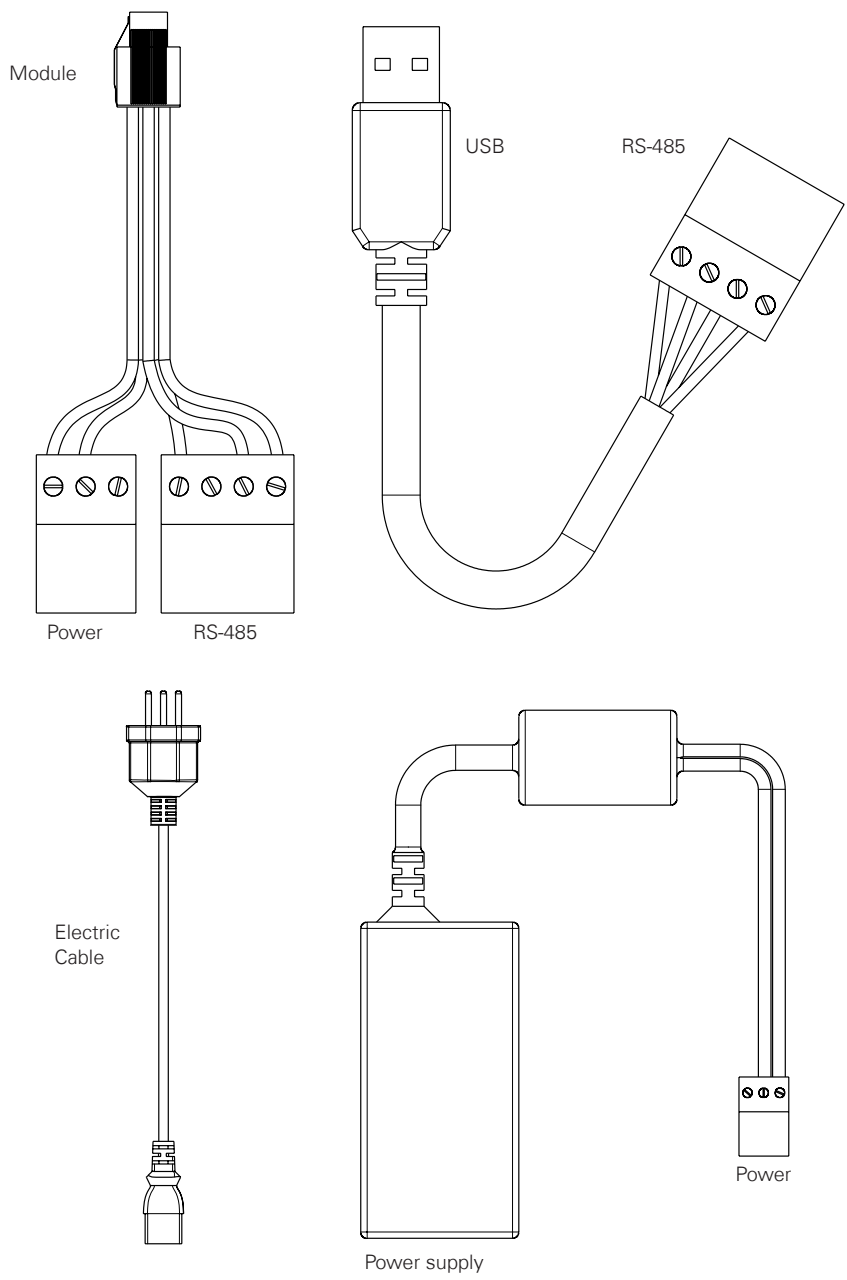

Figure 1

# Data sheet FISBA READYBeam™

## Technical Specifications

	Wavelength <sup>1)</sup>					
	405 nm	450 nm	488 nm	520 nm	638 nm	660 nm
FISBA READYBeam™ bio 1 1006061	x		x		x	
FISBA READYBeam™ bio 2 1008062			x	x	x	
FISBA READYBeam™ ind 1 1006062		x		x		x
FISBA READYBeam™ ind 2 1007773		x		x	x	
Output power calibrated values <sup>2)</sup>	40 mW	40 mW	30 mW	30 mW	40 mW	40 mW
Power stability 8 h	< 2%					
Fiber type	SM/PM, 3 µm core, end capped, APC Connector					
Fiber cable length	1 m					
Polarisation ratio <sup>3)</sup>	typ. 17 dB					
Spatial mode	TEM 00					
M2	< 1.1					
Optical noise RMS, 20Hz – 20MHz	typ. 0.2, max. 0.5 %					
Laser operation modes	CW, modulated					
Digital modulation	TTL input					
Digital modulation frequencies	1 MHz					
Digital rise time 10 – 90%	11 ns					
Digital fall time 90 – 10%	11 ns					
Analog modulation bandwidth	0 – 3.3 V input voltage					
Analog modulation frequencies	20 KHz					
Analog rise time 10 – 90%	12 µsec					
Analog fall time 90 – 10%	12 µsec					
Laser safety class	3B					
Max. storage temperature range	- 10° C to + 60° C					
Operational temperature range	+ 15° C to + 40° C					
Power consumption	typ. 5W, max. 12 W					
Temperature stabilization	internal TEC controlled					
Communication interface	RS 485					

<sup>1)</sup> Laser center wavelength tolerances: **405:** 400 – 410nm ; **450:** 440 – 460nm; **488:** 486 – 490nm; **520:** 515 – 530 nm; **638:** 632 – 643nm; **660:** 655 – 665nm

<sup>2)</sup> linear calibrated power range from 10% to 100% (max)

<sup>3)</sup> min.13dB, max. 26 dB

## Definition of QR Code information

- Specification 1 Item number
- Specification 2 Serial number
- Specification 3 Final inspection date

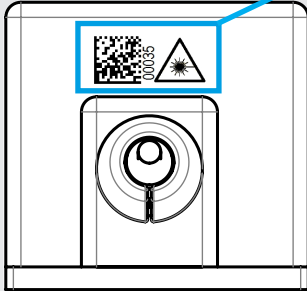

FISBA AG

Rorschacher Str. 268  
9016 St.Gallen  
Switzerland

FISBA Photonics GmbH

Schwarzschildstrasse 10  
12489 Berlin  
Germany

FISBA North America

6 Willey Road  
Saco, ME 04072  
United States

FISBA (Shanghai) Co., Ltd.

Room 501, 5th Floor, Building 3  
No. 898, Zhenchen Rd  
Baoshan District, 200444 Shanghai  
China

[fisba.com](http://fisba.com) | [readybeam@fisba.com](mailto:readybeam@fisba.com)

